

OPTICON

2D Barcode Scanner

OPI 4002



The OPI 4002 is a 2D barcode scanner that provides wireless communication compliant with IEEE 802.15.4 between the OPI 4002 and a host system.

Specifications Manual

All information subject to change without notice.

Document History

Model Number:	OPI 2002	Specification Number:	SS06077
Edition:	1A	Original Spec Number:	SS06076
Date:	2006-12-22		

Copyright 2006 Opticon. All rights reserved.

This manual may not, in whole or in part, be copied, photocopied, reproduced, translated or converted to any electronic or machine readable form without prior written consent of Opticon.

Limited Warranty and Disclaimers

PLEASE READ THIS MANUAL CAREFULLY BEFORE INSTALLING OR USING THE PRODUCT.

Serial Number

A serial number appears on all Opticon products. This official registration number is directly related to the device purchased. Do not remove the serial number from your Opticon device. Removing the serial number voids the warranty.

Warranty

Unless otherwise agreed in a written contract, all Opticon products are warranted against defects in materials and workmanship for two years after purchase. Opticon will repair or, at its option, replace products that are defective in materials or workmanship with proper use during the warranty period. Opticon is not liable for damages caused by modifications made by a customer. In such cases, standard repair charges will apply. If a product is returned under warranty and no defect is found, standard repair charges will apply. Opticon assumes no liability for any direct, indirect, consequential or incidental damages arising out of use or inability to use both the hardware and software, even if Opticon has been informed about the possibility of such damages.

Packaging

The packing materials are recyclable. We recommend that you save all packing material to use should you need to transport your scanner or send it for service. Damage caused by improper packaging during shipment is not covered by the warranty.

Trademarks

Trademarks used are the property of their respective owners.

Opticon Inc. and Opticon Sensors Europe B.V. are wholly owned subsidiaries of OPTOELECTRONICS Co., Ltd., 12-17, Tsukagoshi 4-chome, Warabi-shi, Saitama, Japan 335-0002. TEL +81-(0) 48-446-1183; FAX +81-(0) 48-446-1184

SUPPORT

USA

Phone: 800-636-0090

Email: support@opticonusa.com

Web: www.opticonusa.com

Europe

Email: support@opticon.com

Web: www.opticon.com

Contents

1. Abstract	6
2. Overview	6
3. Physical Features	7
3.1. Dimensions	7
3.2. Weight	7
3.3. Color	7
4. Environmental Specifications	7
4.1. Operating Temperature and Humidity	7
4.2. Storage Temperature and Humidity	7
4.3. Ambient Light Immunity	8
5. Electrical Specifications	8
5.1. Main Battery	8
5.2. Battery Operating Time and Charging Time	8
5.3. AC Adaptor	9
5.4. Operating Indicators	9
5.4.1. LED Indicator and Buzzer	9
6. Optical Specifications	10
6.1. Imager Scanning	10
7. Technical Specifications	10
7.1. Test Samples: 1D Symbologies	11
7.2. Test Samples: 2D Symbologies	11
7.3. Print Contrast Signal (PCS)	12
7.4. Minimum Resolution	12
7.5. Scan Area and Resolution	13
7.5.1. Depth of Field	13
7.6. Pitch, Skew, and Tilt	14
7.7. Curvature	15
8. Aiming	16
8.1. Aiming Patterns	16
8.2. Aiming Guidelines	16
9. Interface Specifications	17
9.1. Wireless Interface	17

- 9.2. IEEE 802.15.4 17
 - 9.2.1. Radio Equipment 17
 - 9.2.2. Frequency Band..... 17
- 10. Default Settings 18**
 - 10.1. Set Default Interface 18
 - 10.1.1. Default Settings..... 18
 - 10.2. Configuring Settings by Reading Menu Barcode Labels..... 18
 - 10.2.1. Address Registration to Connect with OPA 1001 18
 - 10.2.2. Wireless Communication Channel Settings: CH11–CH26 18
 - 10.2.3. Data Memorizing Settings Outside the Communication Range: DTME/DTMD..... 18
 - 10.3. Default Settings 1: Readable Codes 19
 - 10.4. Default Settings 2: Read Options, Trigger, Buzzer 20
 - 10.5. Default Settings 3: Other Communication Settings..... 21
- 11. Serial Number and Labeling 21**
 - 11.1. FCC Label 21
- 12. Packaging Specifications 22**
 - 12.1. Collective Packaging Specification 23
- 13. Durability 24**
 - 13.1. Electrical Noise 24
 - 13.2. Static Electricity..... 24
 - 13.3. Shock 24
 - 13.3.1. Drop Test (without packaging)..... 24
 - 13.3.2. Drop Test (with individual packaging)..... 24
 - 13.4. Vibration Strength 24
 - 13.5. Dust and Drip Proof..... 25
- 14. Reliability..... 25**
- 15. Regulatory Compliance 26**
 - 15.1. LED Safety 26
 - 15.2. Product Safety..... 26
 - 15.3. EMC 26
 - 15.4. RoHS..... 26
 - 15.5. R&TTE 26
 - 15.6. Radio Law 27
 - 15.7. State of California: Perchlorate Best Management Practices 27

16. Safety 28

16.1. Shock 28

16.2. Temperature Conditions..... 28

16.3. Foreign Materials 28

16.4. Other 28

16.5. AC/DC Adapter 28

17. Mechanical Drawing 29

Table of Figures

Figure 1: Depth of field 13

Figure 2: Pitch, skew, and tilt..... 14

Figure 3: Curvature..... 15

Figure 4: Aiming patterns..... 16

Figure 5: Serial number diagram 21

Figure 6: FCC label 21

Figure 7: Individual packaging 22

Figure 8: Collective packaging..... 23

Figure 9: Mechanical drawing..... 29

1. Abstract

This manual provides master specifications for the OPI 4002 2D barcode scanner (hereafter referred to as “scanner”).

2. Overview

The OPI 4002 includes the following features:

- A 1.3 million-pixel (SXGA) CMOS area image sensor, and a compact camera module with wide-angle lens that enables scanning of wider symbologies at higher resolution
- Wide-angle lens optics that make it possible to scan wider symbologies at closer distances
- A small, high-performance, power-saving decoder that processes data faster and provides smoother scanning of both linear (1D) and 2D symbologies
- Wireless communication compliant with IEEE 802.15.4 (an interface standard for ZigBee physical layer and MAC layer) is the interface between the OPI 4002 and a host system
- The scanner is supplied with an IEEE 802.15.4 dongle to establish wireless communication through the USB port of hosting hardware.
- Scanner settings can be configured by scanning menu labels.
- A lithium-ion secondary battery is used as the power supply for the scanner.
- Connect a dedicated AC adapter or an optional charger directly to the OPI 4002 to charge the battery.
- The OPI 4002 complies with the Restriction of Hazardous Substances (RoHS).

Supported symbologies:

Linear (1D)	Postal Code	2D
JAN/UPC/EAN, incl. add-on	Chinese Post	Aztec Code
Codabar/NW-7	Korean Postal Authority Code	Aztec Runes
Code 39		Composite Codes
Code 93		Data Matrix (ECC 0-140, ECC200)
Code 128		Maxi Code (mode 2~5)
GS1-128 (EAN-128)		MicroPDF417
GS1 Databar (RSS)		Micro QR Code
IATA		PDF417
Industrial 2of5		QR Code
Interleaved 2of5		
ISBN-ISSN-ISMN		
Matrix2of5		
MSI/Plessey		
S-Code		
Telepen		
Tri-Optic		
UK/Plessey		

3. Physical Features

3.1. Dimensions

W 58.1 mm x D 42.4 mm x H 163.9 mm

3.2. Weight

125 grams, max.

3.3. Color

Light gray

4. Environmental Specifications

4.1. Operating Temperature and Humidity

Temperature: 0 to 40° C

Humidity: 5 to 90% RH

4.2. Storage Temperature and Humidity

Temperature: -20 to 60° C

Humidity: 5 to 90% RH

4.3. Ambient Light Immunity

Decoding performance is guaranteed when the range of illumination on a barcode surface is between zero and the following values:

Incandescent light	to 10,000 lx
Fluorescent light	to 10,000 lx
Sunlight	to 100,000 lx

Direct light or specular reflection from a light source should be prevented from entering the acceptance area.

5. Electrical Specifications

5.1. Main Battery

The main battery is a lithium-ion secondary battery.

Nominal capacity: 1100 mAh

Nominal voltage: 3.6 V

Item	Specifications	Conditions
Consumption current	15 mA (max.)	When idle
	250 mA (max.)	When scanning
	550 mA (typ.)	When charging

5.2. Battery Operating Time and Charging Time

Items	Specifications	Conditions
Battery life	30 hours (min.)	1 scan / 5 s Discharge and charge 300 times Battery capacity 70% (1C charging)
Charging time	3 hours	Time necessary to fully charge an empty battery

Note: Battery life may be shorter than specified above when the quality of the battery pack is degraded.

Conditions

Ambient temperature: +25°

Symbology: 1-digit Code 39, PCS = 0.9, Resolution = 1.0 mm

Distance: 85 mm from the front edge of the scanner. (Single read)

5.3. AC Adaptor

The OPI 4002 can be charged by an optional AC adaptor of 6.0 V / 750 mA. This optional adaptor is used for charging the internal battery.

Conditions

Connect 1Ω resistance to a power supply line in series and measure the current by the voltage between both ends of resistance.

Power supply voltage is measured at a connector terminal area.

The current value depends on the interface type and host computer to which the device is connected.

5.4. Operating Indicators

5.4.1. LED Indicator and Buzzer

The OPI 4002 uses LEDs and a buzzer to indicate its status.

State	Color	Display	Operating State	Buzzer
Charging	Red	Lighting	Shows that the scanner is being charged.	-
	Green	Lighting	The light changes from red to green when charging is completed.	-
Scanning	Green	Blinking	Shows that the scan or transmission was executed normally.	<i>Trrr</i>
	Red	Blinking	Shows that the data could not be transmitted.	<i>Pip, Pip, Pip</i>
	Orange	Blinking	Shows that the data is being stored in memory.	<i>Trrrrrrrrrr</i>
Wireless Connection	Green	Lighting	Shows that registration was completed.	<i>Peeeeeeeep (Completion of Registration)</i>
	Red	Lighting	Shows that registration failed.	<i>Pip, Pip, Pip</i>

6. Optical Specifications

6.1. Imager Scanning

Parameter	Specification	Unit
Scanning method	CMOS area sensor (black and white)	—
Effective pixels	1280 (H) x 1024 (V)	dots
Frame rate	30	fps
Aiming LED wavelength (2 green LEDs)	527	nm
Lighting LED wavelength (4 red LEDs)	630	nm
View angle	Horizontal: 47 Vertical: 37.5	°
Focal length	85	mm

Notes:

Refer to chapter 7, “Technical Specifications,” to read about scanning performance.

7. Technical Specifications

The conditions for technical specifications are as follows, unless otherwise specified in each section.

Conditions

Ambient temperature and humidity:	Room temperature (5 to 35° C) Room humidity (45% to 85% RH)
Ambient light:	1000 to 1500 lx (on the surface of a barcode)
Light source:	3-wavelength inverter fluorescent light
Angles:	$\alpha = 0^\circ$, $\beta = +15^\circ$, $\gamma = 0^\circ$
Curvature	$R = \infty$
Background:	Barcode = black Space = white Margin = white Background of label = black
Power supply voltage:	3.6 V
Decoding test:	Approve the performance when decoding is successful in 70% or more of the tests

7.1. Test Samples: 1D Symbologies

The size of barcodes does not include quiet zones.

1D Barcode

Resolution	Symbology	PCS	Size (mm)	Digits
0.254 mm	Code 39	0.9	14 x 10	2
0.1 mm	Code 39	0.9	11 x 10	4
0.26 mm	13-digit JAN	0.9	25 x 19	13
0.26 mm	8-digit JAN	0.9	17.5 x 15.5	8

Barcode samples with 0.127 mm and 0.26 mm resolution are OPTOELECTRONICS test samples. Other charts are printed by a regular printer.

N/W Ratio: 1:2.5
 Angle: $\alpha = 0^\circ, \beta = 15^\circ, \gamma = 0^\circ$
 Curvature $R = \infty$

7.2. Test Samples: 2D Symbologies

PDF417

Resolution	Error Correction	PCS	Size (mm)	Characters
0.127 mm	Level-4	0.9	13 x 8	17
0.254 mm	Level-4	0.9	26 x 16.5	17
0.339 mm	Level-4	0.9	35 x 22	17

Charts are printed by a regular printer.
 Horizontal to vertical ratio is 3:1

Data Matrix

Resolution	Model	PCS	Size (mm)	Characters
0.169 mm	ECC200	0.9	4 x 4	40
0.339 mm	ECC200	0.9	8 x 8	40

QR Code

Resolution	Model	PCS	Size (mm)	Characters
0.169 mm	M	0.9	5 x 5	44
0.339 mm	M	0.9	10 x 10	44

7.3. Print Contrast Signal (PCS)

0.45 or higher (over 70% of reflectivity of space and quiet zone).

$$\text{PCS} = \frac{\text{Reflectance of white bar} - \text{Reflectance of black bar}}{\text{Reflectance of white bar}}$$

Scanning performance may decline if dirt or scratches mar the optical window. Keep the optical window clean.

7.4. Minimum Resolution

Resolution	Symbology
0.1 mm	Code 39
0.127 mm	PDF417
0.169 mm	QRCode
0.169 mm	Data Matrix

7.5. Scan Area and Resolution

7.5.1. Depth of Field

The depth of field is measured from the edge of the optical window.

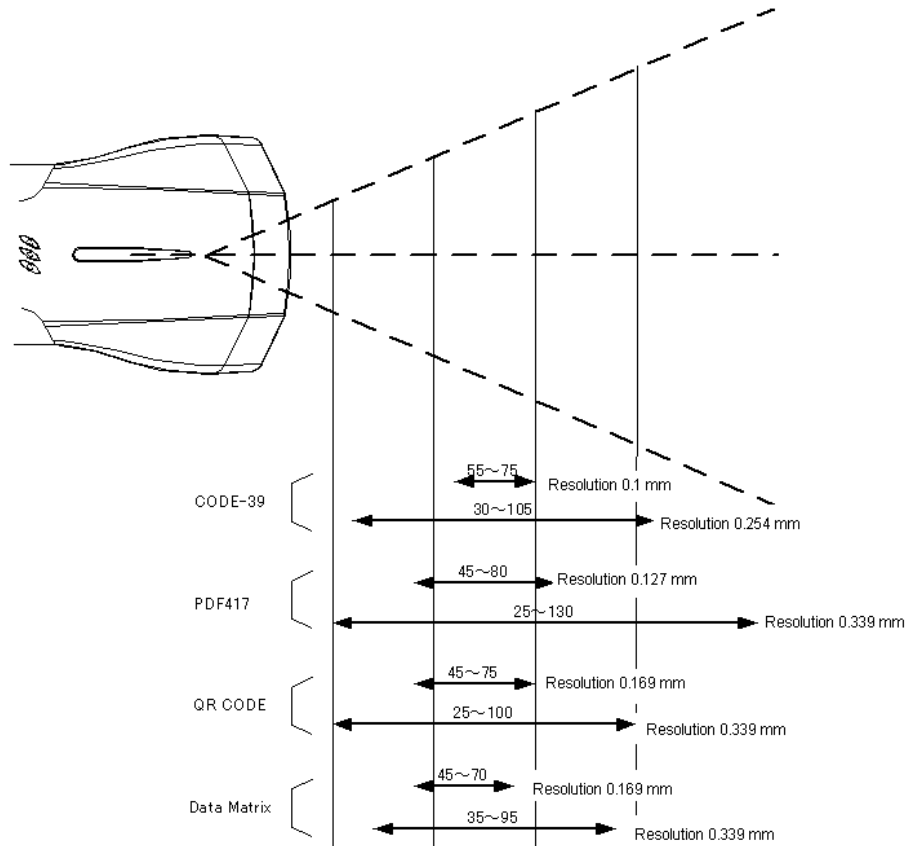

Figure 1: Depth of field

Symbology	Resolution (mm)	Decode Depth (mm)	PCS
Code 39	0.1	55~75	0.9
	0.254	30~105	
PDF417	0.127	45~80	0.9
	0.339	25~130	
QR Code	0.169	45~75	0.9
	0.339	25~100	
Data Matrix	0.169	45~70	0.9
	0.339	35~95	

7.6. Pitch, Skew, and Tilt

Pitch: $\alpha = \pm 50^\circ$

Skew: $\beta = \pm 60^\circ$ or less

Tilt: $\gamma = 360^\circ$ or less

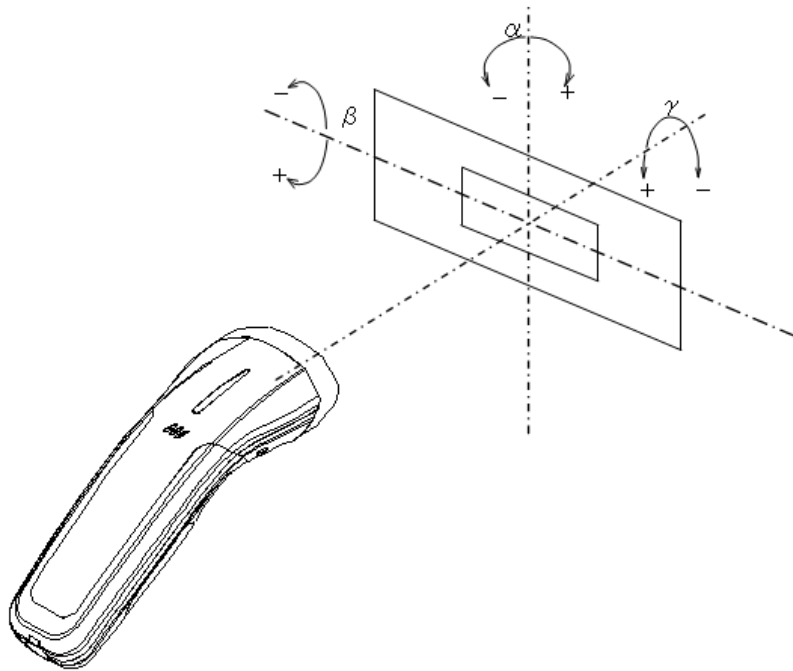

Figure 2: Pitch, skew, and tilt

Conditions

Barcode Sample: CODE39 and PDF417 with 0.254 mm resolution, PCS: 0.9

Distance: 56 mm from the front edge of the scanner

Curvature: $R = \infty$

(The calculation of pitch and tilt angles is based on the skew angle formula being $\beta = +15^\circ$)

Notes

When a barcode is printed on glossy paper or a card case, it may cause difficulties in scanning due to the reflection of lighting LEDs. To improve scanning performance under these circumstances, scan the barcode with a scan angle of 15 degrees or with lighting LEDs turned off. When scanning a barcode with lighting LEDs turned off, confirm that there is enough ambient lighting in the room (1000 lx or higher), or scanning performance may decline. Scanning performance may also decline if room light reflects on the barcode surface.

7.7. Curvature

With 8-digit JAN/UPC/EAN barcodes, decoding performance is guaranteed when $R \geq 15$ mm.

With 13-digit JAN/UPC/EAN barcodes, decoding performance is guaranteed when $R \geq 20$ mm.

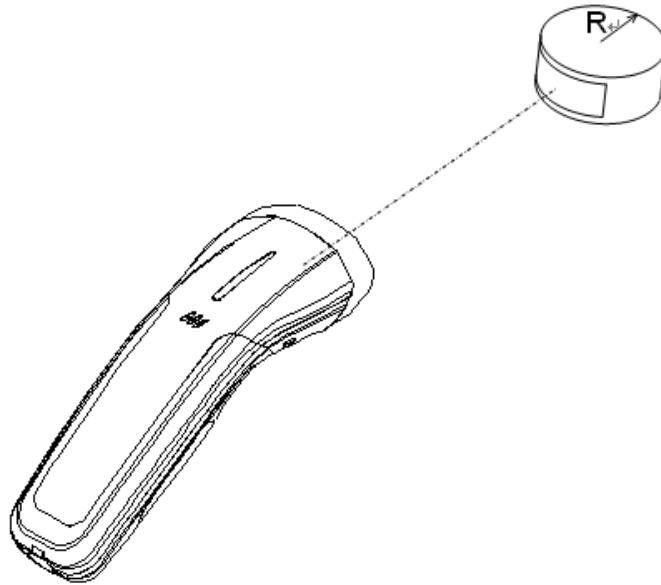

Figure 3: Curvature

Conditions

Barcode Sample: Symbology: 13-digit JAN, resolution: 0.26 mm, PCS: 0.9 mm

Distance: 56 mm from the front edge of the scanner

Angle: $\alpha = 0^\circ$, $\beta = +15^\circ$, $\gamma = 0^\circ$

8. Aiming

8.1. Aiming Patterns

During a scan, the green LED patterns shown below will be visible. These patterns assist you in aiming the scanner; they are superimposed on the illuminated scan field. The aiming patterns are only a guide. They do not indicate exact scannable width or distance between a scanner and a barcode.

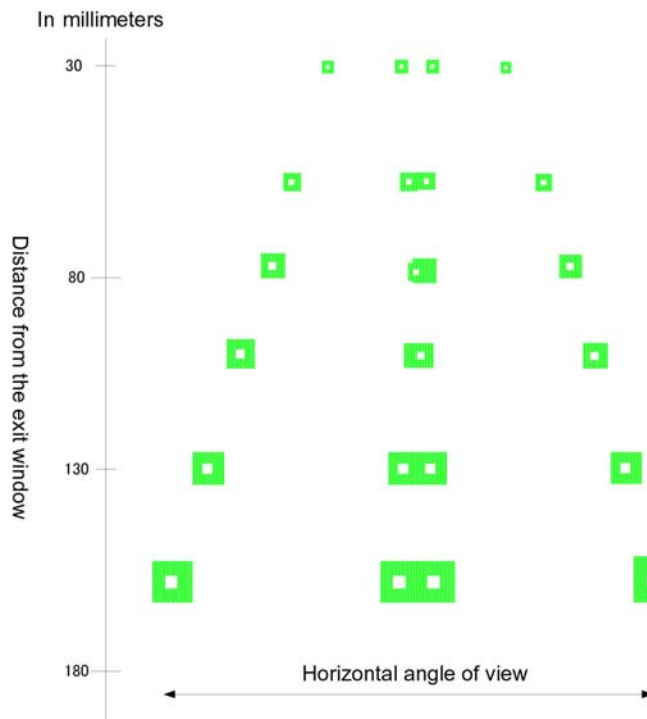

Figure 4: Aiming patterns

8.2. Aiming Guidelines

- The focal point is where two central LED light patterns (green and square-shaped) overlap—where two dots meet.
- To scan a barcode within the aiming range, make sure that two central LED light patterns overlap, then place the center of the overlapping LED light patterns on the center of the barcode.
- To scan a barcode wider than a width of the aiming range, aim at the barcode from further away. Make sure that the barcode is between two LED light patterns on both the right and left.
- Scanning performance may decline due to the specular reflection when the symbology is printed on certain types of materials. In such cases, incline the scanner at 15 degrees to adjust the scanning angle.

9. Interface Specifications

9.1. Wireless Interface

Complies with IEEE 802.15.4 (ZigBee's physical layer and MAC layer).

Item	Specification	Notes
Frequency	2400 MHz to 2483.5 MHz	
Communication specification	IEEE 802.15.4 compliant	
Transmission power	0 dBm or less	
Communication distance	30 m or longer	Depends on the environment.
Baud rate	250 Kbps	
Antenna	1/4λ surface-mounted type	
Communication configuration	One OPI 4002 to one OPA 1001	
Encryption	128-bit encryption	

9.2. IEEE 802.15.4

9.2.1. Radio Equipment

The electromagnetic wave absorption (2.4 GHz) used by this product is also shared by various other devices. Therefore, baud rate and communication distance may be negatively impacted, or their communications may be disconnected, by other devices using the same absorption rate.

Baud rate and communication distance are affected by obstacles, wave conditions, or a device at the other end.

This product is equipped with an antenna. Bringing this product too close to a metallic object may affect communication. Anticipated interference distance is 10 m or less.

9.2.2. Frequency Band

This product uses the 2.4 GHz frequency band. Scientific, medical, and industrial devices, including microwaves, wireless security (camera) systems and W-LAN use the same frequency band as this scanner. Other radio stations also use this frequency for mobile object identification, including local private radio stations that require a license (for example, manufacturing lines at factories), specific power-saving radio stations requiring no license, and amateur radio stations.

Interference from other devices may affect the communication speed or communication range of this scanner or vice versa.

10. Default Settings

10.1. Set Default Interface

Scan the following menu barcodes to return to the default settings.





There are two ways to configure factory default settings:

- One-by-one configuration by scanning the Code 39 menu labels below.

Note: When duplicated scanning of a menu label occurs, the last label scanned will take effect.

- Multi-configuration by scanning the QR code menu label below.

10.1.1. Default Settings

Code 39 Menu Labels for One-by-One Configuration			QR Code Label for Multi-Configuration
ZZ	Set		
C02	Interface Settings IEEE802.15.4 HID Data Transmission		
ZZ	End		

10.2. Configuring Settings by Reading Menu Barcode Labels

Communication parameter settings for the OPI 4002 can be configured by scanning menu labels.

Refer to the instruction manual for further information about menu labels.

10.2.1. Address Registration to Connect with OPA 1001

Read an address barcode printed on the label attached to the OPA 1001 cradle.

Confirm that the OPA 1001 is connected to the OPI 4002

Note: Scanned data cannot be transmitted unless the address registration is completed.

10.2.2. Wireless Communication Channel Settings: CH11–CH26

The wireless communication channel settings can be adjusted.

10.2.3. Data Memorizing Settings Outside the Communication Range: DTME/DTMD

Selecting “Data Memorizing Enabled” allows the scanner to read data outside the communication range and store the data in OPI 4002 memory. When the scanner

returns to the communication range, it will be re-connected and the temporarily stored data will automatically be transmitted to the host.

Note: When “Data Memorizing Disabled” is selected, the scanner will not read data outside the range.

10.3. Default Settings 1: Readable Codes

Symbology	Read	Transmit Code Length	Transmit CD	Calculate CD	Set Prefix	Set Suffix	Other
UPC-A	■	X	■	■	—	CR	
UPC-A Add-on	X	X	■	■	—	CR	
UPC-E	■	X	■	■	—	CR	
UPC-E Add-on	X	X	■	■	—	CR	
EAN-13	■	X	■	■	—	CR	
EAN-13 Add-on	X	X	■	■	—	CR	
EAN-8	■	X	■	■	—	CR	
EAN-8 Add-on	X	X	■	■	—	CR	
Aztec Code	■	X	X	■	—	CR	
Aztec Runes	X	X	X	■	—	CR	
Codabar / NW-7	■	X	■	X	—	CR	Not transmit ST/SP
Code 39	■	X	■	X	—	CR	Not transmit ST/SP
Code 93	■	X	■	■	—	CR	
Code 128	■	X	■	■	—	CR	
Data Matrix (ECC0-140)	X	X	X	■	—	CR	
Data Matrix (ECC200)	■	X	X	■	—	CR	
GS1-128 (EAN/UCC-128)	X	X	X	■	—	CR	
GS1 DataBar (RSS) (all, incl. CC-A/B); Omnidirectional/ Truncated/ Stacked/Limited/ Expanded	X	X	X	■	—	CR	
IATA	■	X	■	X	—	CR	
Industrial2of5	■	X	■	X	—	CR	
Interleaved2of5	■	X	■	X	—	CR	
Matrix2of5	X	X	■	X	—	CR	
Maxi Code	■	X	X	■	—	CR	

Symbology	Read	Transmit Code Length	Transmit CD	Calculate CD	Set Prefix	Set Suffix	Other
MicroPDF417	■	X	X	■	—	CR	
Micro QR	X	X	X	■	—	CR	
PDF417	■	X	X	■	—	CR	
QR Code	■	X	X	■	—	CR	
MSI/Plessey	■	X	■CD1	■CD1	—	CR	
UK/Plessey	■	X	■	■	—	CR	
S-Code	■	X	■	X	—	CR	
Telepen	■	X	■	■	—	CR	
Tri-Optic	■	X	■	X	—	CR	Not transmit ST/SP

Notes:

In the “Reading” column, “■” means “Enable reading” and “X” means “Disable reading.”

In the “Transmit code length” column, “■” means “Transmit code length” and “X” means “Do not transmit code length.”

In the “Transmit CD” column, “■” means “Transmit check digit” and “X” means “Do not transmit check digit.”

In the “Calculate CD” column, “■” means “Calculate check digit” and “X” means “Do not calculate check digit.”

“—” means “not supported.” In the “Prefix” column, “—” means “there is no prefix setting.”

10.4. Default Settings 2: Read Options, Trigger, Buzzer

Item	Default Setting
Setting the number of characters	Fixed length OFF all codes
Read mode	Multiple read
Multiple label read	Disable
NW-7 intercharacter gap check	Up to 1 character
Trigger switch	Enable
Read time	2 seconds (when trigger enabled)
Buzzer duration	200 ms
Buzzer frequency	3kHz + 2.5 kHz
Buzzer loudness	Loud
Good read LED	Indicator duration 200 ms

10.5. Default Settings 3: Other Communication Settings

Item	Setting
Set IEEE address	None
Wireless channel	CH15
Encryption	Enabled
Data memorizing	Disabled

11. Serial Number and Labeling

The serial number is written on the following label attached to the scanner.

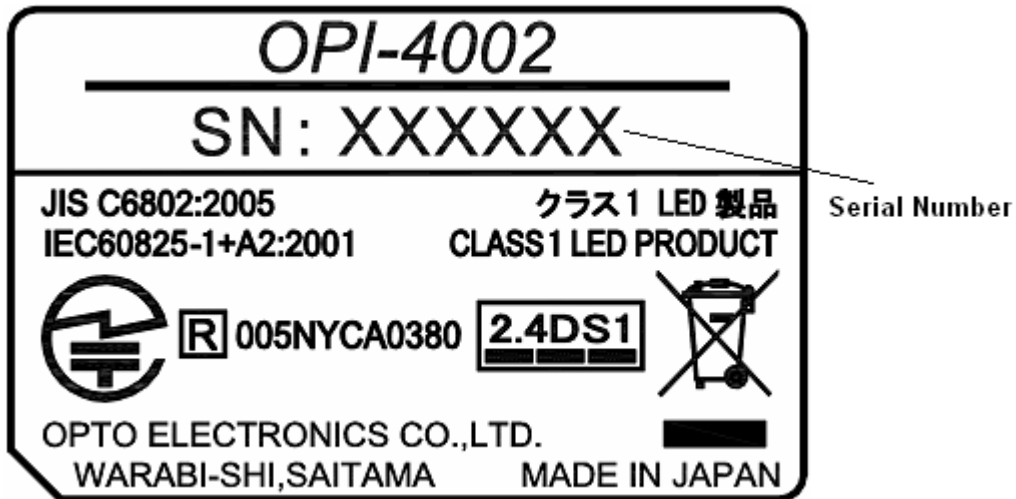

Figure 5: Serial number diagram

11.1. FCC Label



Figure 6: FCC label

12. Packaging Specifications

Put the scanner in a protective foam bag and place it in an individual packing box.

Package dimensions (assembled): 255 mm (W) x 120 mm (D) x 105 mm (H)

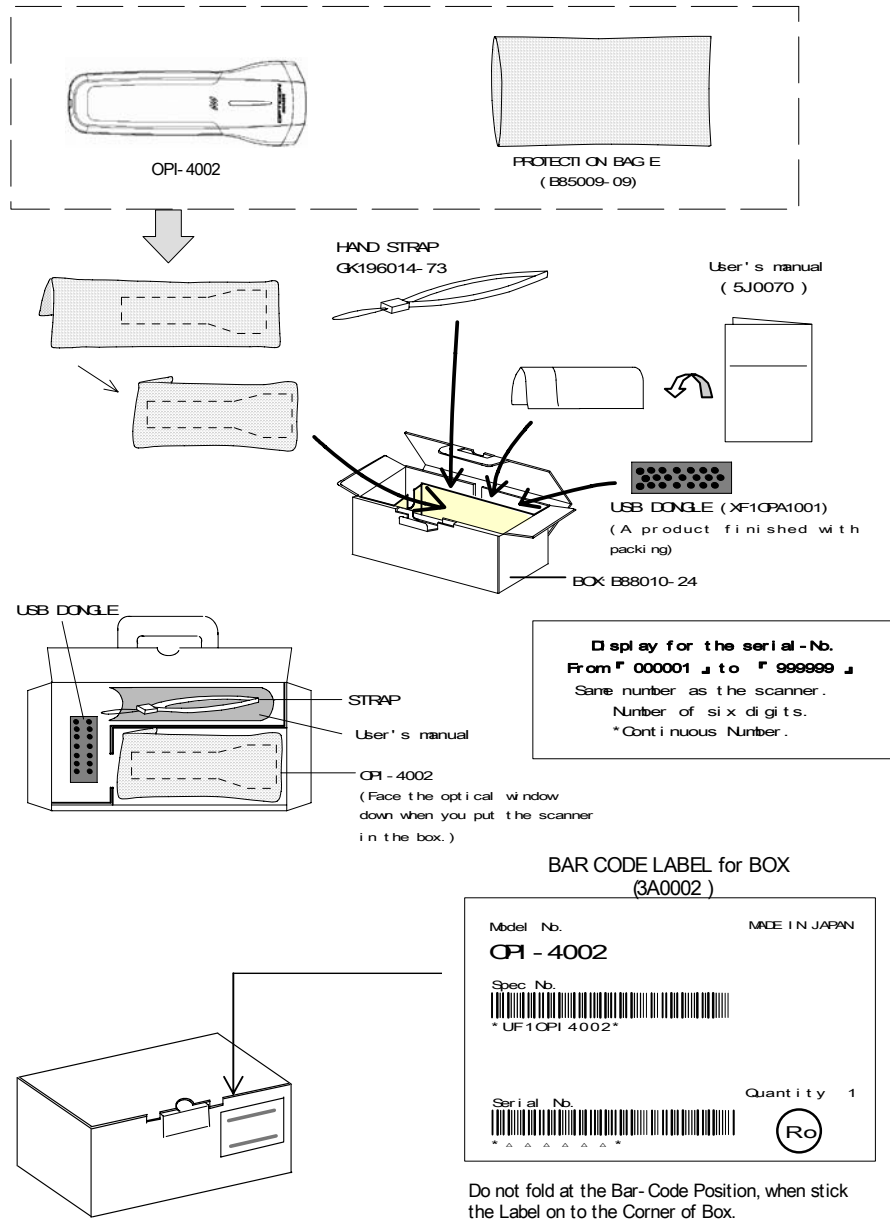

Figure 7: Individual packaging

12.1. Collective Packaging Specification

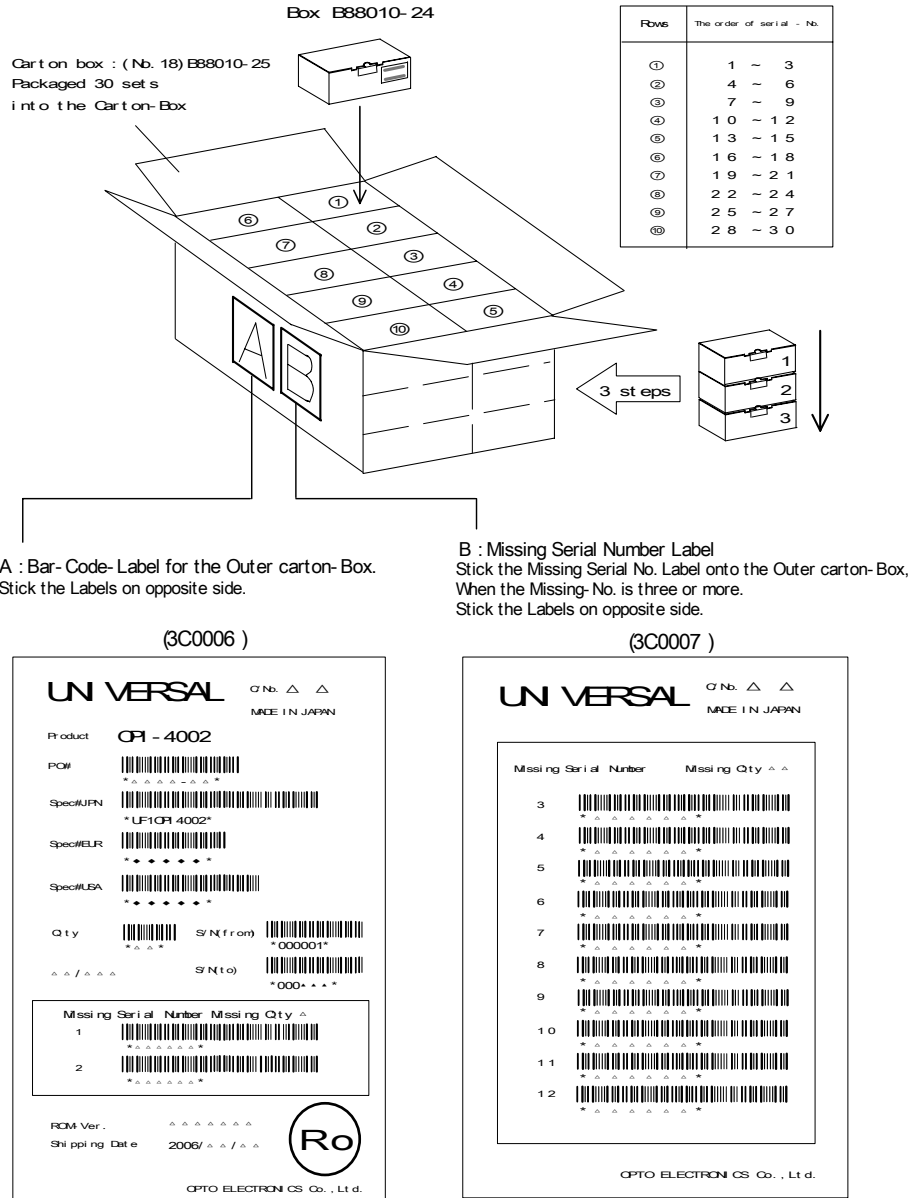

Figure 8: Collective packaging

Note: The “RO” mark labeled on the package tray or package box guarantees that the applicable product has passed our test of RoHS restrictions compliance (the restriction of the use of certain hazardous substances in electrical and electronic equipment, 2002/95 EC). However, this document does **not** have any legal weight in the European Union.

13. Durability

13.1. Electrical Noise

No malfunction occurred when sinusoidal electrical noise (50 Hz–100 kHz, < 0.1 Vp-p) was added to the power supply line.

13.2. Static Electricity

Air discharge (No malfunction): ± 10 kV max.

Air discharge (No destruction): ± 15 kV max.

Conditions

Measurement environment: Use electrostatic testing device compliant with IEC 61000-4-2
Built up and discharged 15 kV of static electricity on the scanner surface 50 times.

Discharge resistance: 330 Ω

Capacitor charging: 150 pF

13.3. Shock

13.3.1. Drop Test (without packaging)

No malfunction occurred after the following drop test.

Drop Test: Drop the scanner from 1.5 meters onto a concrete floor three times on each of its six sides. Scratches on the chassis are not counted as a defect.

13.3.2. Drop Test (with individual packaging)

No malfunction occurred after the following drop test.

Drop Test: Dropped the individually packaged scanner from 1.5 meters onto a concrete floor once on its one corner, three edges, and six sides. Repeated for ten drop tests, total.

13.4. Vibration Strength

No malfunction occurred after the following vibration test.

Put the OPI 4002 into a non-operating state and carried out sweeping for 30 minutes, increasing the frequency of the vibration from 10 Hz to 100 Hz with accelerated velocity of 2.0 G (19.6m/s^2). (60 minutes for one cycle). Repeated this cycle to X, Y and Z directions.

13.5. Dust and Drip Proof

IEC IP42

Dust Prevention

Level	Details
4	Prevention of objects larger than 1 mm. Most wires, screws, etc.

Water Prevention

Level	Details
2	Vertically dripping water shall have no harmful effect when the enclosure is tilted at an angle up to 15° from its normal position.

14. Reliability

MTBF (Mean Time Between Failures) of this product is 50,000 hours.

The estimate of MTBF and product life cycle is based on standard operation of the product within the recommended temperature range and without extreme electronic or mechanical shock.

The MTTR (Mean Time To Repair) of this product is one hour.

15. Regulatory Compliance

15.1. LED Safety

All LED-based products are LED class 1 and are safe under reasonably foreseeable operating conditions. Do not stare into the beam.

- JIS C6802: 2005: Class 1
- IEC 60825-1+A2: 2001 Class 1

15.2. Product Safety

EN60950-1: 2001

IEC60950-1: 2001

15.3. EMC

EN55022

EN55024

VCCI Class B: This is a Class B product, to be used in a domestic environment based on the Technical Requirement of the Voluntary Control Council for Interference from Information Technology Equipment (VCCI). If this is used near a radio or television receiver in a domestic environment, it may cause radio interference. Please install and use the equipment according to the instruction manual.

FCC Part 15 Subpart B Class B: This device complies with part 15 of the FCC Rules. Operation is subject to the following two conditions: (1) this device may not cause harmful interference, and (2) this device must accept any interference received, including interference that may cause undesired operation.

15.4. RoHS

RoHS: The restriction of the use of certain hazardous substances in electrical and electronic equipment, 2002/95 EC.

15.5. R&TTE

This scanner conforms to the following standards of the Radio and Telecommunications Terminal Equipment (R&TTE) directive from the EU.

EN300 328

IEC60950-1

15.6. Radio Law

The scanner qualifies as radio equipment for low-power radio stations (2.4 GHz band advanced data communication systems) as specified in the Radio Law 38-24-1.

The scanner has obtained the Certification for Construction Design of Specified Radio Equipment. It does not have a radio station license in Japan.

The following activities are prohibited under the Radio Law:

Remodeling and disassembly

Peeling off the certificate label

15.7. State of California: Perchlorate Best Management Practices

The batteries on some Opticon products may contain Perchlorate. To comply with California Perchlorate Best Practice Regulations and the Law for the Promotion of Utilization of Recyclable Resources (Japan), products that may contain Perchlorate materials should be properly labeled on the exterior of all outer shipping packages and/or in locations that otherwise satisfy the California Perchlorate Best Management Practices.

16. Safety

Handle this product carefully. Do not deliberately subject it to any of the following.

16.1. Shock

Do not throw or drop the scanner.

Do not drop or put heavy items on this product or its cable.

16.2. Temperature Conditions

Do not use the scanner at temperatures outside the specified range.

Do not use near heat sources such as radiators, heat registers, stoves, or other types of devices that produce heat.

Do not use in areas exposed to direct sunlight for long periods of time.

Do not pinch or forcibly bend the cable, especially at very low temperature.

16.3. Foreign Materials

Do not use the scanner near water or other liquids, as well as in extremely high humidity.

Do not immerse the scanner in liquids.

Do not use in dusty environments.

Do not subject the scanner to chemicals.

Do not insert foreign substances into the device.

16.4. Other

Do not plug/unplug the connectors before disconnecting the power.

Do not attempt to disassemble, modify or update this device.

Do not use near microwaves, medical devices, or RF-emitting devices.

The scanner may not perform properly in environments when placed near a flickering light, such as a computer monitor, television, etc. Do not use in the reach of blinking lights such as CRT.

The scanner may be damaged by voltage drops.

16.5. AC/DC Adapter

Opticon shall not be held responsible for any damages caused by using an AC adapter not provided by Opticon.

Use only the supplied AC adapter with the enclosed region specific plugs for connection to the wall socket.

This product may produce heat when in use, but it does not affect its performance.

17. Mechanical Drawing

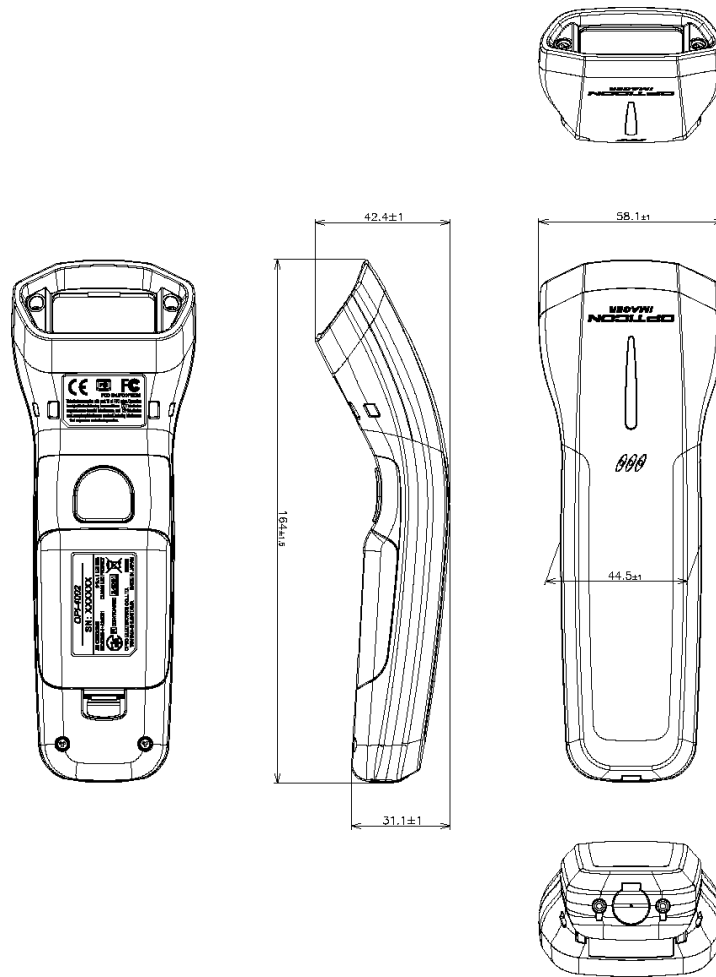

Figure 9: Mechanical drawing